

AIR CONTROL EXTRACTOR

AIR-TRAC[®]

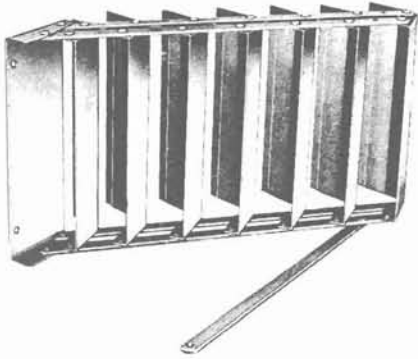

THE AIR-TRAC[®] MODEL EX UNIT UNIFORMLY DIVERTS AIR FROM THE MAIN DUCT INTO THE BRANCH TAKE-OFF, OR ACROSS THE FACE OF THE GRILLE.

STANDARD UNIT CONSISTS OF A BANK OF CURVED BLADES ON TWO INCH CENTERS. EACH BLADE IS SYNCHRONIZED WITH THE OTHER AND ENTIRE UNIT PIVOTS ON BASE PLATE. UNIT PIVOTS FROM FULL OPEN TO FULL CLOSED WITH BLADES OVERLAPPING FOR FULL SHUT OFF.

STANDARD MATERIAL IS GALVANIZED STEEL.
 BLADES - 24GA BASE - 18GA STRAPS - 16GA

- | | |
|------------------|--|
| STYLE EX - 1 | STANDARD UNIT WITH ADJUSTING STRAP. |
| STYLE EX - 1 - R | ROD OPERATOR FOR EXTERNAL OPERATIONS. |
| STYLE EX - 2 | HAS LINKAGE WITH 3/8" SQUARE HOLE FOR EXTERNAL OPERATIONS. |
| STYLE EX - 3 | HAS FACTORY INSTALLED GEAR OPERATOR WITH OPERATING CRANKS. |
| STYLE EX - 3 - S | SAME AS EX - 3 EXCEPT IT MAY BE OPERATED FROM THE SIDE. |
| STYLE EX - SM | HAS SIDE MOUNTED BASE FOR MOUNTING OVER ROUND TAKE-OFF. |

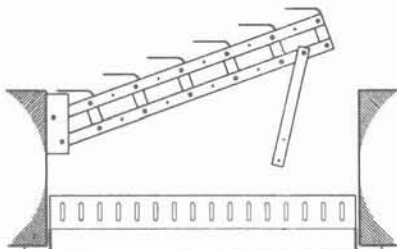

STYLE EX-1

001-EX

LISTED SIZE - 1/8"

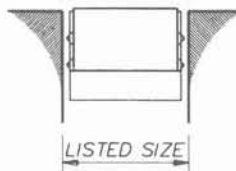

LISTED SIZE

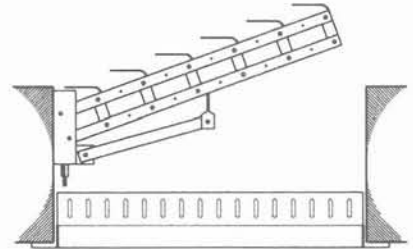

STYLE EX-3

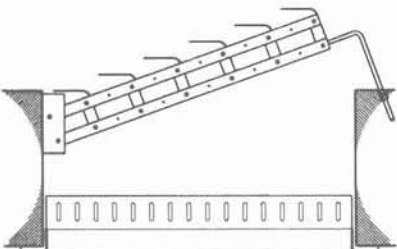

STYLE EX-1-R

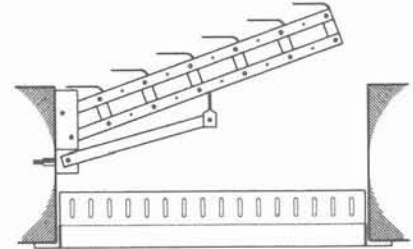

STYLE EX-3-S

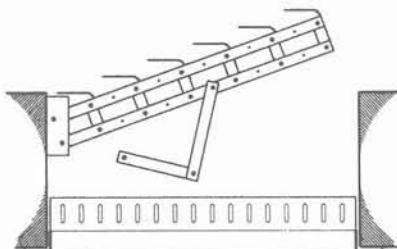

STYLE EX-2

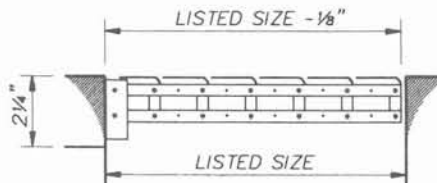

LISTED SIZE - 1/8"

LISTED SIZE

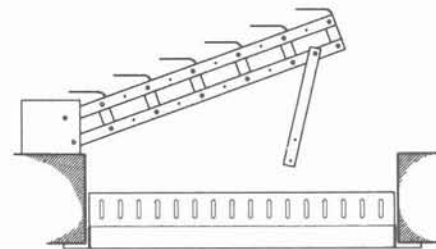

STYLE EX-SM

LARGER UNITS IN ALL STYLES REQUIRE ADDITIONAL SUPPORT

FOR LARGER SIZES COMBINE ABOVE PRICES AND ADD 10%.

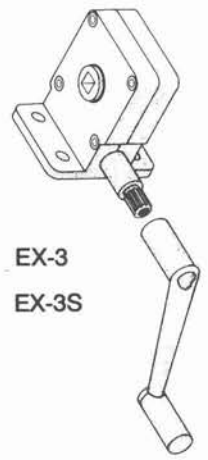
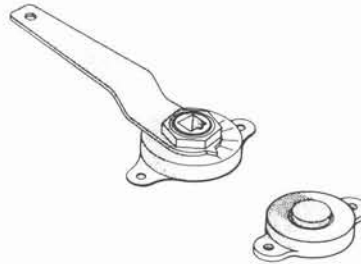
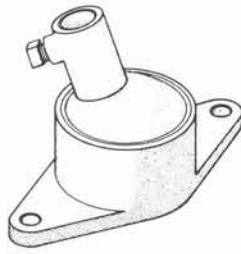
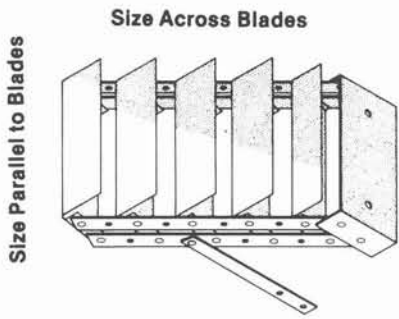

EX-1 Example: 12 x 6
size across blades size parallel to blades